

USER MANUAL

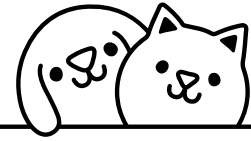

furmates

LIMO

PET MOBILITY
SYSTEM

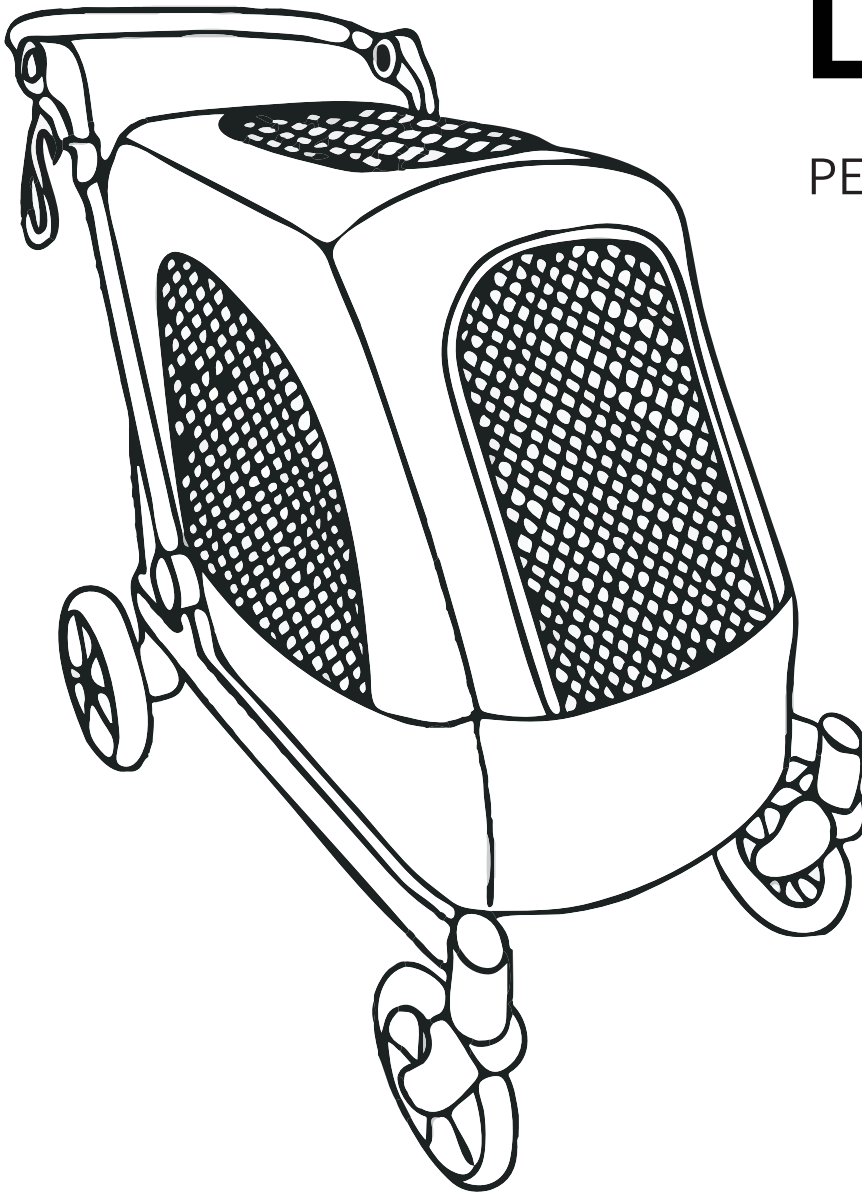

scan me



IMPORTANT! KEEP FOR FUTURE REFERENCE

SPECIFICATIONS

- PLEASE NOTE: This stroller is specifically designed for use with pets only! NEVER use with babies or children.
- Follow the Manufacturer's instructions.
- The Limo Pet stroller is suitable for use with pets up to a maximum weight 50 kg.
- Make sure children/ pets are clear of the Hauler pet stroller when folding, unfolding or even adjusting the Hauler, failure to do so could result in injury.
- Attaching any additional load to your Limo Pet Stroller chassis wil negatively affect its stability.
- Always keep fingers away from moving parts when folding, unfolding, or adjusting your Limo Pet stroller to prevent finger/body part entrapment or pinching.
- It is unsafe to use replacement parts other than those supplied or approved by the manufacturer
- Be aware of the risk of open fire and other sources of strong heat, such as electric bar fires, gas fires, heaters, etc., in the near vicinity of the Limo Pet Stroller.
- Please make sure all parts are securely engaged and connected before using.
- Contact at info@valiantbrands.com.au to obtain the most up to date information.

PARTS

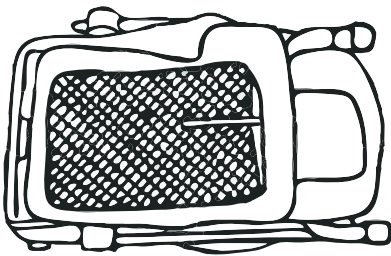

Stroller main body

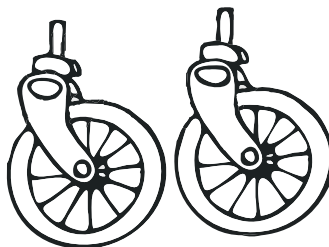

Front wheels x2

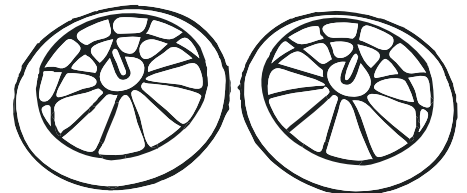

Rear wheels x2

ASSEMBLY INSTRUCTIONS

1. Place the frame on a flat and safe place. Put cardboard on the floor so as not to scratch the floor.

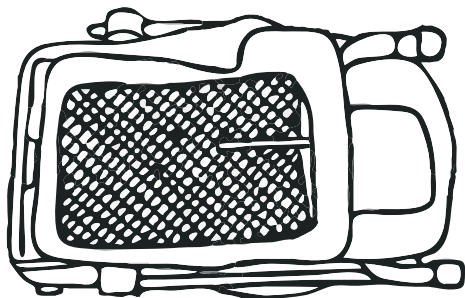

2. Back wheels are assembled by inserting the wheel into the wheel mount until it locks into place. Gently pull on the Rear Wheel to make sure it is properly attached.

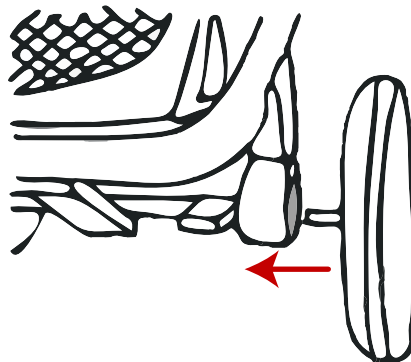

3. Attach the front wheel by sliding it into the front wheel mount until it clicks. Gently pull on the front wheel to make sure it is properly attached.

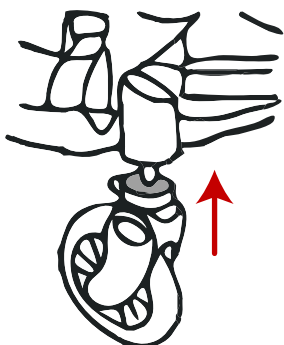

4. Disengage the folding latch of the retaining belt from the rivet head on the chassis (4a). You may have to press down on the handle to release some pressure in order to disengage the strap.

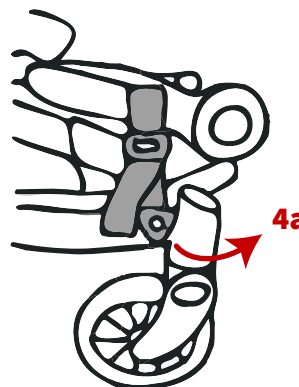

5. Move the handle by simultaneously pressing the 2 release buttons at either side while pulling upward (5a).

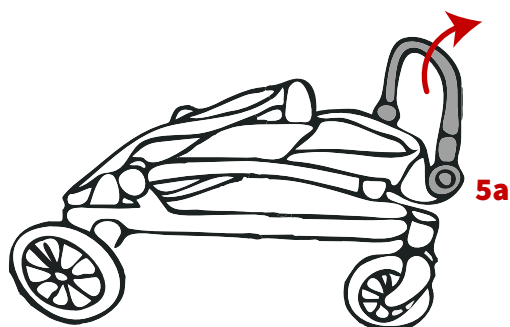

ASSEMBLY INSTRUCTIONS (continued)

- 6.** Continue lifting the handle upward until you feel the chassis fully open and the locks at either side (**6a**) "click" into place. Ensure that all the locking devices are fully engaged before use.

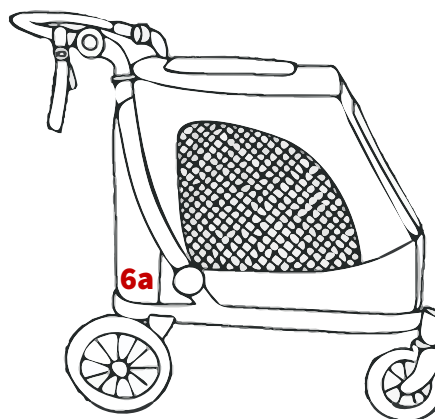
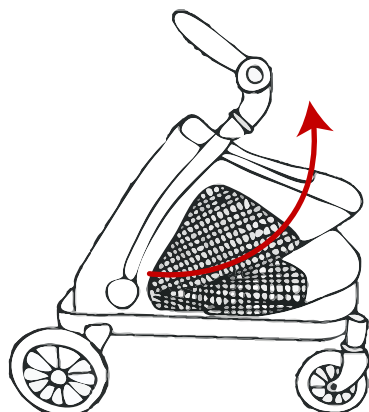

USE INSTRUCTIONS

- 1. BRAKE:** Push the brake pedal down (**1a**) to engage the brake. Lift up the brake pedal to release.

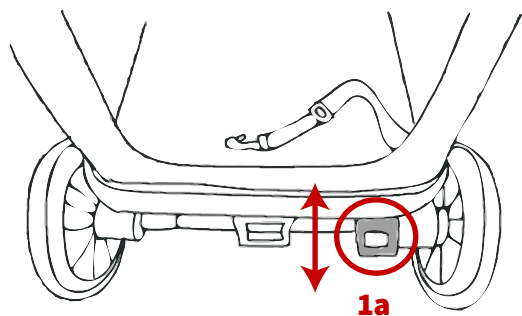

- 2. SWIVEL LOCK:** To lock a front wheel, press in the button (**2a**) at the side of the wheel housing and turn the wheel till it locks in place. This can be helpful when using the Limo on rougher terrain.

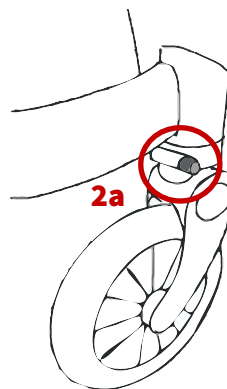

To release the wheel and to return it to 360 degree swivel rotation, simply push the same button out from the other side of the housing.

- 3.** Open the zip, roll up the back mesh window and secure it with the velcro straps. Your pet can now enter and exit the Limo on their own.

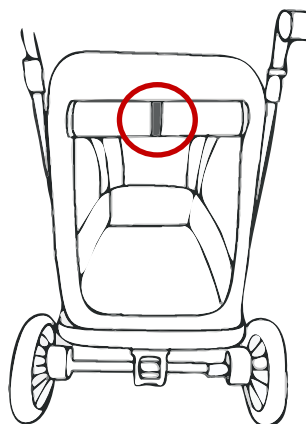
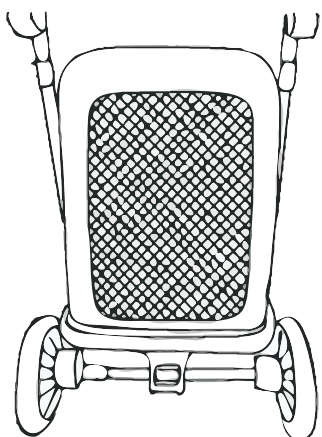

USE INSTRUCTIONS (continued)

4. The front mesh also can provide your pet with access from the front of the Limo. Open the front zip and roll the mesh downward. It can then be stored in the convenient pocket located in the internal front section of the carrier (4a)

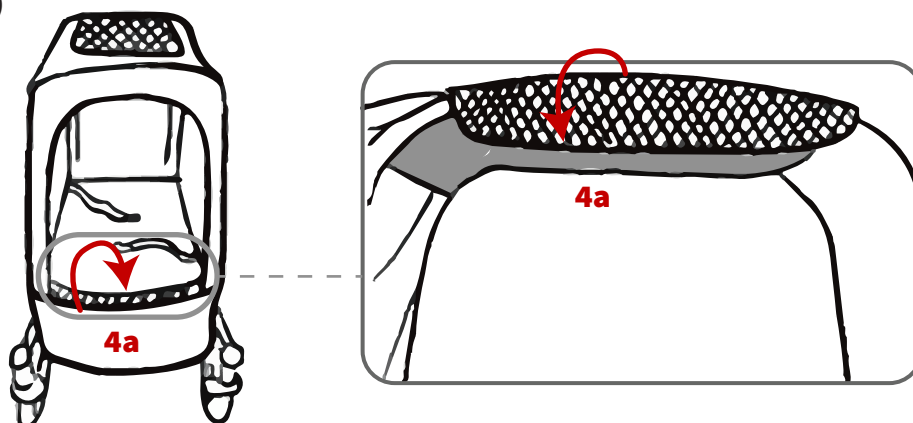

5. The top window opens as illustrated.

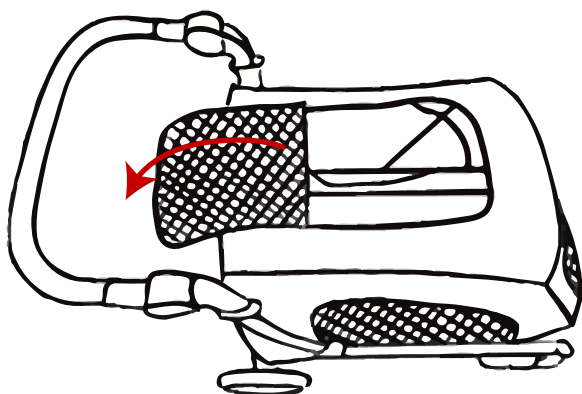

6. Adjust the handle height by simultaneously pressing the 2 release buttons at either side while moving it to the desired position (6a).

7. Always use the built-in leash whenever a pet(s) is/are in the stroller.

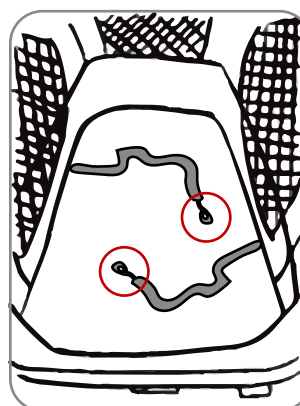
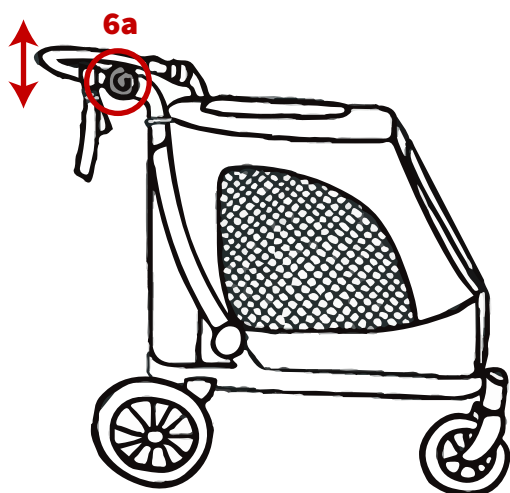

FOLDING THE STROLLER

1. Simultaneously lift the 2 release locks (**1a**) at either side of the stroller handle. When you feel the frame lock release, move the handle forward as indicated (**1b**), Continue pushing downward as far as it will go.

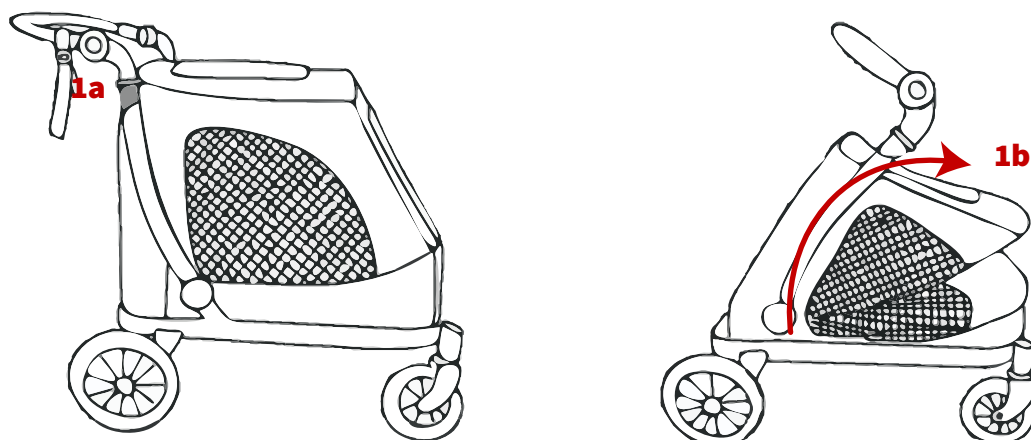

2. To create the most compact outcome, fold the handle backward as far as it will go (**2a**) using the method outlined previously. Secure the frame closed by placing the hole in the plastic head of the retaining strap over the rivet head on the chassis (**2b**)

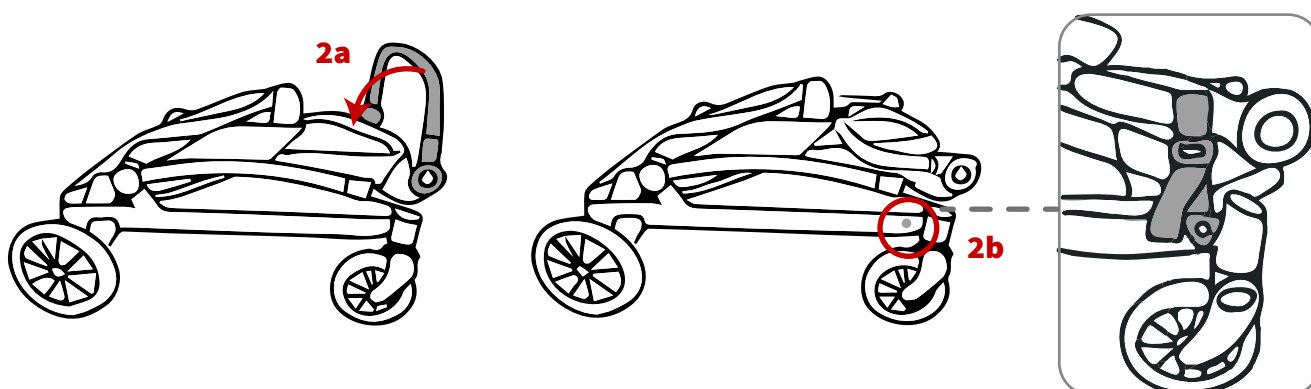

3. If required, flip the standing pedal (**3a**) outward so the Limo can stand when folded.

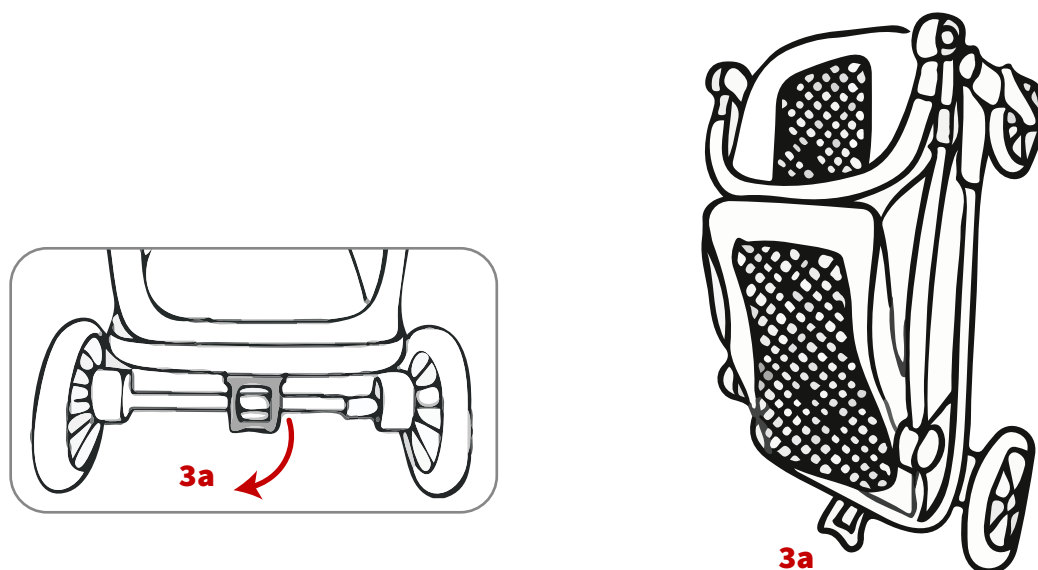

ROUTINE MAINTENANCE

Wipe off any dirt with a dampened cloth. For stubborn dirt, dilute a mild detergent and apply directly to the dirty area. Wipe off the detergent and dry well before folding.

Do not use any chemical cleaners, such as bleach.

If the water repellent function weakens, reapply with a commercially available water repellent spray.



Hand Wash Gentle Warm



Do Not Use Bleach



Dry Flat



Do Not Iron



Do Not Dry Clean

IMPORTANT NOTICE

Caution: Always be aware of the need to open the cover of the mesh window to allow ventilation.

Be mindful that during times of high temperatures or, even in relatively low temperature conditions but areas of direct sunlight, the temperature inside the carry bag is higher than the external area. Always open the mesh window cover and ventilate adequately when a pet is inside the carrier.

SAFETY INSTRUCTIONS

- PLEASE READ AND UNDERSTAND ALL INSTRUCTIONS AND SAFETY WARNINGS PRIOR TO USING:
- ALWAYS CHECK THAT THE BRAKES ARE SECURELY ENGAGED BY MOVING THE STROLLER BACK AND FORTH.
- DO NOT USE LIMO PET STROLLER UNLESS YOUR PET IS COMFORTABLE AND SECURED COMPLETELY.
- WHEN USING THE STROLLER, ENSURE THAT YOUR PET IS CORRECTLY ATTACHED TO THE JUMP-OUT PREVENTION LEAD IN THE CARRIER AND ADJUST THE LENGTH SO YOUR PET CANNOT JUMP OUT.
- ALWAYS HOLD THE HANDLE TIGHTLY WHEN THE STROLLER IS IN USE. ENSURE TO LOCK THE REAR FOOT BRAKES WHEN YOU'VE STOPPED. DO NOT STOP THE STROLLER ON SLOPING ROADS/UNEVEN ROADS/ROUGH ROADS.
- NEVER LEAVE YOUR PET IN THE STROLLER UNATTENDED. THIS MAY RESULT IN AN ACCIDENT, SUCH AS THE STROLLER ROLLING AWAY, OR TIPPING OVER, OR YOUR PET MAY HAVE SUFFER HEAT STROKE OR BECOME DEHYDRATED. AVOID LEAVING YOUR PET IN THE CARRIER FOR AN EXTENDED TIME.
- THE LIMO PET STROLLER IS DESIGNED FOR PETS WITH A MAXIMUM WEIGHT OF 50 KG/ 110 LBS.

SAFETY INSTRUCTIONS (continued)

- YOUR PET MUST ALIGHT BEFORE REACHING PAVEMENT EDGES, STAIRS, STEEP PATHS, TIGHT CORNERS, AND/OR WHILST MANOEUVRING BACKWARD.
- ENSURE ALL SCREWS AND MOUNTINGS OF THE PRODUCT ARE FIRMLY ENGAGED AND ALL PARTS ARE CONNECTED PROPERLY.
- NEVER MAKE ALTERATIONS TO THE LIMO PET STROLLER TO AVOID COMPROMISING ITS SAFETY.
- CLEAN ALL THE PARTS AND WHEELS FROM TIME TO TIME WITH WARM SOAPY WATER. DRY THOROUGHLY.
- PLEASE KEEP THE LIMO PET STROLLER PACKAGING MATERIALS AWAY FROM PETS AND CHILDREN.
- IN THE EVENT OF ANY POSSIBLE DAMAGE TO THE LIMO PET STROLLER, ONLY ORIGINAL REPLACEMENT PARTS FROM THE MANUFACTURER MUST BE USED FOR REPAIR.
- KEEP THE INSTRUCTION MANUAL CAREFULLY FOR FUTURE REFERENCE AND ANY POSSIBLE SUBSEQUENT USERS.
- THE LIMO PET STROLLER IS NOT A TOY. IT IS NOT SUITABLE FOR CHILDREN.
- TO GUARANTEE THE SAFETY AND FUNCTIONALITY OF THIS DEVICE, AVOID ANY OVERLOADING.
- UNDER NO CIRCUMSTANCES, CAN THE LIMO BE USED FOR TRANSPORTING ADDITIONAL ITEMS OR OCCUPANTS.
- DO NOT HANG ITEMS ON THE HANDLE. THIS MAY CAUSE THE STROLLER TO BECOME UNBALANCED AND TIP OVER.
- NEVER USE YOUR LIMO PET STROLLER ON STAIRS OR ESCALATORS.
- DO NOT LEAVE THE STROLLER IN THE CAR IN EXCESSIVE TEMPERATURE OR HEAT. AS PARTS MAY BECOME DEFORMED AND THE STROLLER MAY NOT FUNCTION PROPERLY.
- MAKE SURE TO DRY THE STROLLER OFF AFTER USE IN THE RAIN TO AVOID RUSTING AND MOULD.
- STOP USING THE STROLLER IMMEDIATELY, IF THERE IS ANY BREAKAGE.

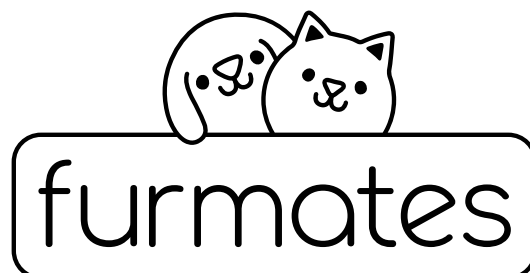

LIMO

furmates.com.au